

ozone

BLASTER

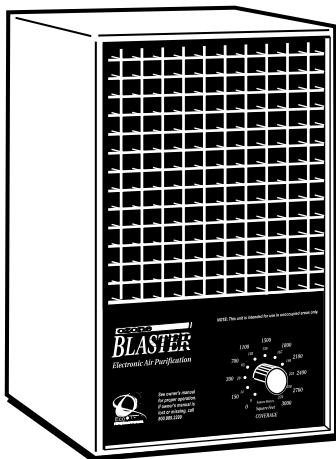

OWNER'S MANUAL

- Application
- Notable Features
- Specifications
- Installation
- Operation
- Maintenance
- Warranty

Ozone Blaster Adjustable

Electronic Air Purification



310 T. Elmer Cox Drive • Greeneville, TN 37743 • 423.638.7246

www.EcoQuest.com

CAUTION: read manual carefully for proper procedures and operation.

You can find this and other owners manuals online at <http://eee.ecoquestintl.com/ownersmanuals>

CONTENTS

Applications	3
Notable Features	3
Model Specifications	3
Principles of Operation	4
Pre-Installation / Inspection	4
Ozone Plate/Lint Screen Install	5
Placing the Unit	6
Setting / Adjusting Controls	7-8
Maintenance	8-9
Troubleshooting	10-11
Warranty	12

Please record the serial number of your CAIR unit:

Serial # _____

Please record the name and phone of your EcoQuest Dealer:

_____ Name

_____ Phone



**CAUTION! - Disconnect power cord before servicing.
Use 1.0 AMP slow blow fuse.**

CAUTION: Do not operate unit without one or all ozone plate(s) properly installed. Doing so may void your warranty.

Applications

Eliminate

- Smoke
- Odors
- Tobacco Smoke

Plus it works as an appliance to Sanitize an area to Reduce

- Mold
- Mildew
- Bacteria

For use in your Salon, Smoke Damaged Areas, Apartment, Office, Automobile, Boat... anywhere you need clean air!

Notable Features

- Compact
- Portable
- No Duct Work Required
- No Chemicals
- Low Maintenance
- Low Electrical Use
- Complete User Control
- No Residual Contamination
- Plugs into 110 (or 220) volt outlet

Specifications

- Ozone Generation

Features:

- Adjustable fan speed control
- Washable permanent lint screen
- Adjustable ozone control

Electrical:

- 120 volt 60 Hz or 220v 50 Hz
- 30 watts power consumption

Mechanical:

- 350 CFM fan
- One front-mounted control for ozone output

Size:

- Height: 11 3/4"; Width: 8"; Depth: 9 3/4"
- Weight: 16 pounds

Ozone Output:

- 0-1,200 mg per hour

Warranty:

- Industry - best 3 year warranty (US).
Length of warranty will vary depending on model (International).
See warranty card for specific details.

PRINCIPLES OF OPERATION

Nature cleanses the air with the lightning and rain. Lightning bolts produce ozone, as well as positive and negative ions which cleanse the air naturally. Rain helps bring the ozone and ions closer to the earth's surface. They are then attracted to atmospheric contaminants that are either removed from the air and attached to grounded objects or are oxidized.

The Ozone Blaster Adjustable reproduces the natural conditions found in the outdoors and is also designed to create an artificial environment. Ozone has been shown to remove odors and kill mold, mildew, bacteria and viral organisms. It cleanses the air, rather than filtering it, masking the symptoms, or attempting to dilute it.

PRE-INSTALLATION AND INSPECTION

1. Remove unit from shipping carton
2. Remove all protective materials
3. Check for shipping damage and loose or broken parts
4. Read Owners Manual thoroughly prior to installation
5. Remove EcoTech Purification Plates from the box and install
6. OPTIONAL: Plug the unit into a 110 volt (or 220 volt) outlet, place in shipping box with unit on and purifier knob set to maximum for at least one hour to remove traces of manufacturing odor.
7. Determine placement location for the unit, plug the unit into 110 volt (or 220 volt) outlet and adjust controls according to the application.

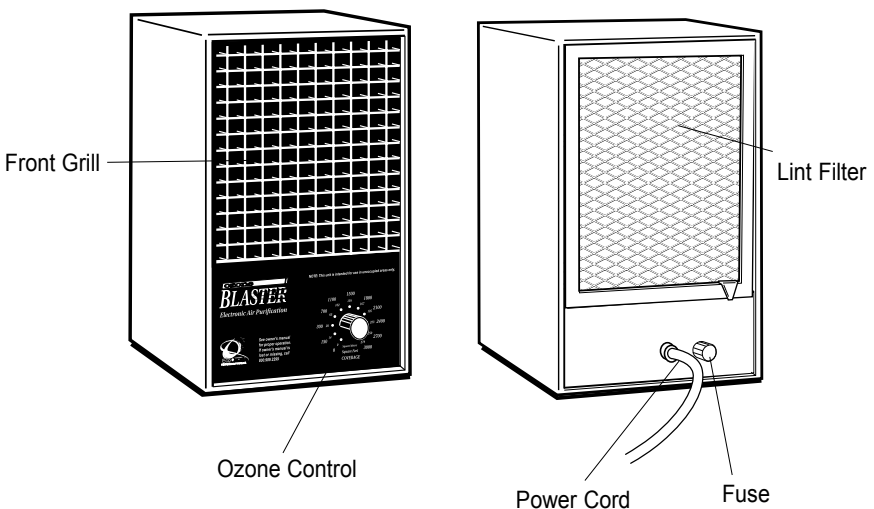

OZONE PLATE INSTALLATION

The Ozone Blaster Adjustable utilizes EcoTech Purification Plates.

1. Remove the rear lint screen.
2. Fully insert the EcoTech Purification Plates (a, & b) between the guide-grooves in the top and bottom of the plate cage (between the posts and clips) making sure the metal clip on each side of the plate is in contact with the metal screen on the plate.
3. Re-install lint screen as shown below.

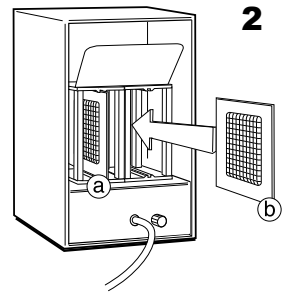
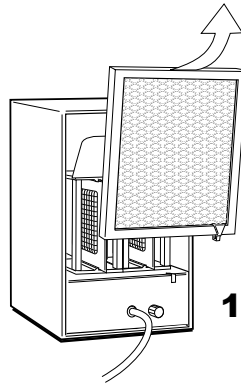

LINT SCREEN INSTALLATION

1. Always install bottom of lint screen first.
2. The white lint screen tab should depress the safety switch arm down.
3. Fit top of lint screen into cabinet.

Unit will not operate if safety switch is not depressed.

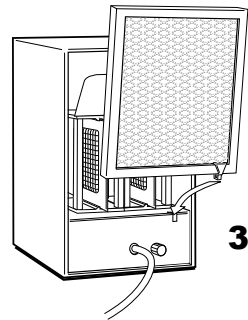
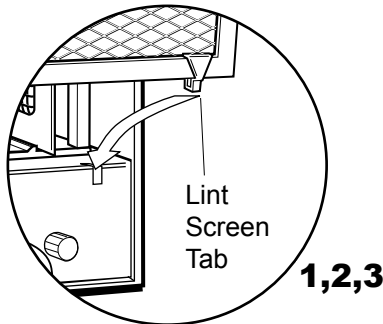

PLACING THE UNIT

Place the unit as high as possible to insure complete purification.

If raised placement is not available, place unit as high as possible and elevate front of unit so fan blows towards ceiling.

Some pollutants, such as smoke, rise and the unit, when elevated, can oxidize the pollutants more effectively. A ceiling fan can also aid in distribution of cleansing properties.

The Ozone Blaster is most effective when placed in a position that allows the ozone to be mixed evenly and thoroughly with the polluted air.

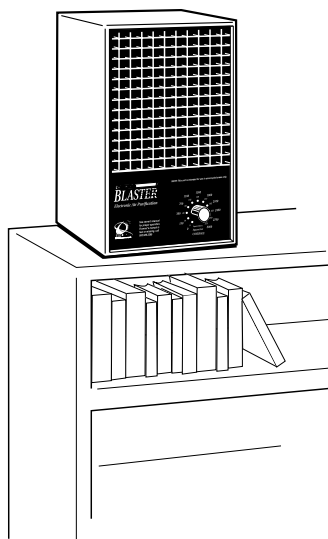

Suggested locations, listed in the order of preference:

1. Nearest the source of the worst pollution.
2. Near a cold-air return to thoroughly circulate clean air throughout the area.
3. In the area most heavily used to achieve maximum benefit.

Note:

- For maximum control the unit should be placed where easy access to the controls is possible.
- The rear of the unit should always have at least one inch of open area to allow unrestricted airflow.
- Be sure power cord is not accessible to small children to prevent injury.

SETTING AND ADJUSTING CONTROLS

1. FAN CONTROL

The disbursement of cleansing properties is best accomplished with good air circulation. This will be determined by personal preference and the distance you wish the cleansing properties to be dispersed.

Note: A ceiling fan can also aid in distribution of cleansing properties.

2. OZONE CONTROL

- Turn the power switch to the “ON” position (this will activate the fan).
- Set the ozone control to the desired quantity of ozone emission. Ozone will then be emitted for an indefinite amount of time.

3. OZONE INFORMATION

Ozone is one of the most powerful oxidizing gases found in all outdoor environments. It is capable of reacting or destroying vast numbers of organic materials found in indoor environments. Used in low dosages, it is capable of controlling odors and restricting the growth of or killing molds, mildews, bacteria and other microorganisms.

As with all useful materials and tools, side effects and risks need to be taken into consideration when using them. Ozone, in extremely high concentrations, is capable of causing eye and skin irritation, coughing, headaches and chest pain, and small lung volume reductions. All reversible upon the lowering or removal of the extremely high levels of ozone.

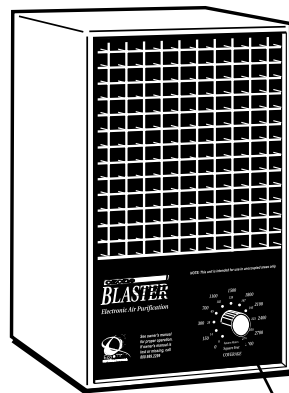

Ozone Control

4. SANITIZING AN AREA

4a. SITE PREPARATION

- Remove the contaminant or debris that may be associated with the source of the problem.
- Clean excess contaminate residue off of surfaces
- Seal the environment intended to be decontaminated. Close vents and air returns. It may be necessary to seal off return vents to prevent leakage of ozone into other areas. It may also be necessary to seal and tape doorways and/or windows to contain the ozone and maximize effectiveness.

4b. SIGNAGE

- During ozone decontamination and for a minimum of 30 minutes after ozone exposure, place signage at all points of access to the treated area. Signage should state “DO NOT ENTER, OZONE TREATMENT IN PROGRESS.”

MAINTENANCE

Periodic maintenance is required to insure that the Ozone Blaster Adjustable operates properly. A severely polluted environment can foul an EcoTech Purification Plate in as little as two weeks or as long as a year. Shown here are basic maintenance procedures that should be carried out to keep your unit running at top performance.

Rear lint-screen filter cleaning:

You have two options to clean the lint screen:

- When visibly dirty, simply remove the lint screen and with a hand-held vacuum remove the heavy particulate from the screen. This method will extend the life of the filter.

- OR -

- When visibly dirty, remove the lint screen from the back of the unit and wash in hot water, brushing gently with a toothbrush to remove particulate. Allow to dry prior to re-installing the lint screen.

Ozone Plate

Carefully remove the EcoTech Purification Plates (a,b) from the card cage by grasping the middle of the edge nearest to you, and slowly pulling straight out.

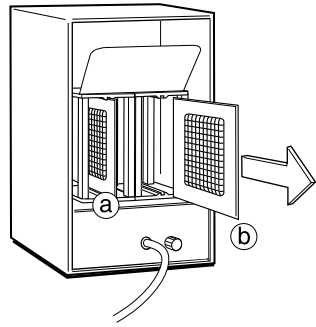
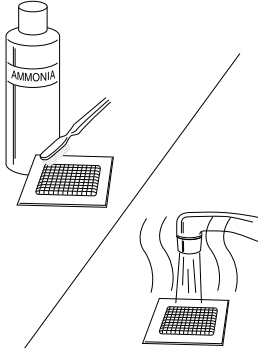

Clean the plate with hot water and ammonia. Dry completely using a hair dryer if necessary. Reinstall plates. Be sure to check that the electrical tabs are in contact with the plate.

Plate Card Cage

Also be sure to clean the stand-offs at the corners of the ozone plate card cage. (A cotton swab with alcohol works well.)

Fan Blade and Front Grill

Wipe off fan blade and front grill if dirty with damp washcloth. The fan requires no maintenance (with the exception of the first time it is used, when it may be necessary to give it a gentle push to get it started). If the fan squeaks, a drop of lightweight oil may be needed on the fan shaft.

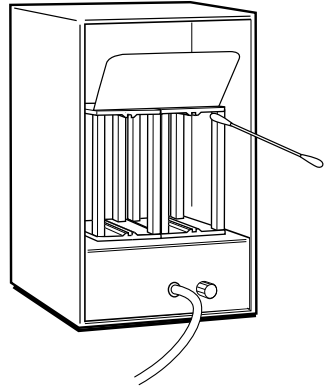

Troubleshooting - What to look for first.

1. I have plugged in the unit, turned "ON" the power switch and nothing happens... what's wrong?

- Make sure the electrical outlet is capable of providing power to the unit.
- Check the lint screen located at the back of the machine to ensure that the safety switch activator clip depresses the safety switch.
- Check to see if the proper fuse is installed and that it is serviceable.
- Ensure that the fuse cap is completely seated and secured in its receptacle.

2. The fan is operating although the unit won't produce any ozone...what's wrong?

- Check the EcoTech Purification Plate(s) for serviceability. If they are cracked or broken, the ozone plate(s) will require replacement. Ensure maintenance procedures required for the ozone plate(s) have been performed according to the "Maintenance" section (page 8-9) of this Owner's Manual. Order new plates from your Dealer.
- Electrical stainless steel contacts are not contacting the screen portion of the EcoTech Purification Plate(s). Inspect the unit for any loose connections.
- Do not attempt to disassemble the unit, due to the Limited Warranty of the product.

3. The EcoTech Purification Plate(s) are making a noise, have a burning smell, and/or appear to arc or spark. What is the problem?

- Plate is most likely cracked. Refer to the answers for question # 2, as it would apply to this question also.

4. What are the most typical application problems?

- **Symptom:** A belief that the proper equipment is placed in the environment and the equipment appears unsuccessful.

Problem: Lack of air movement, improper placement of the unit.

- **Symptom:** Strong odors still remain with the environment after placement.

Problem: Lack of ozone, improper placement of the unit.

- **Symptom:** A strong odor of ozone is present within the environment.

Problem: Too much ozone accumulation within the environment, as a result of improper purifier control setting, and / or lack of air movement.

- **Symptom:** Visual haze of smoke and / or particulate remain within the environment.
Problem: Lack of ionization and / or air movement.

5. *Unit does not operate* -

- Is the unit plugged in?
- Are you sure the outlet is active?
- Is the unit turned on?
- Is the rear lint screen installed properly to depress the safety switch forward?

6. *Air flow is restricted or reduced* -

- Is the unit properly placed away from objects that may obstruct air flow?
- Are the filter and fan housing clean?

If your unit fails to operate properly after performing trouble-shooting, contact your EcoQuest Dealer for further assistance, contact us at the address located in this manual, or visit www.EcoQuest.com for additional technical support.

Ozone Blaster™

Electronic Air Purification

WARRANTY INFORMATION

This product is of solid state construction and is warranted by

EcoQuest International, 310 T. Elmer Cox Drive, Greeneville, TN 37743,

to the original purchaser, to be free from defect in materials and workmanship for three-years from date of purchase. (220 volt units are warranted for one year, parts only.) This warranty excludes ozone plates, which are covered for 90 days from the same date of purchase.

See warranty card for specific details.

If you have any questions concerning your Ozone Blaster system, please see your local EcoQuest Dealer.

If your unit is defective, please contact

EcoQuest International, 310 T. Elmer Cox Drive, Greeneville, TN 37743

or visit www.ecoquest.com for technical help.

Did you forget to register your Ozone Blaster?

By registering, you'll activate your warranty, and your privacy is guaranteed.

Just fill out your warranty card and drop it in the mail.



EcoQuest International®

310 T. Elmer Cox Drive

Greeneville, TN 37743

423.638.7246

www.EcoQuest.com